

MHL 350

LOADING MACHINE



With hydraulically height-adjustable cab

Operating weight 31.5 t (69,450 lbs)

Engine power 122 kW (166 HP)





FUCHS

Technical data

 **Engine** Deutz 7.2 l / 6-cylinder-diesel engine BF6M 1013 E. Water-cooled, direct injection, turbocharged. Power rating acc. ISO 9249 (DIN 70 020) at 2000 r.p.m. 122 kW (166 HP)
Optimum hydraulic performance in all speed ranges through load-limit control. Fuel-saving and noise-reducing auto-idling system. Thermostatically controlled cooling circuit. Minimization of noise emission, radiator contamination and energy consumption provided by thermostatically controlled fan speed.

 **Electrical system** Operating voltage 24 V
Switch box for modularly designed electric system.
2 cold-start high-performance batteries 12 V/ 92 Ah

 **Power transmission**
Infinitely variable drive via variable displacement motor and 2-speed power shift transmission.
Travel speed: high gear . . . 0–20 km/h (12.4 mph)
Travel speed: low gear 0–5 km/h (3.1 mph)
Gradability max. 45 %

 **Steering** Hydrostatic externally powered steering system, emergency steering.

 **Undercarriage/axles** Robust steel structure in box-type design. 40-ton (88,185 lbs.) planetary axles. Rigid steering axle, for safe transport of loads. Oscillating rear axle, with hydraulic oscillating axle lock. Four-wheel drive.

 **Tires** Solid rubber, elastic tires 8-fold 12.00-20

 **Brakes** Service brake: hydraulic power-assisted braking system acting on all four wheels. Parking brake: hydraulic disc brake on 2-gear power shift transmission.

 **Support equipment** Integrated 4-point outriggers, to be operated from cab. Individually controllable as an option.

 **Hydraulic system** Load-Sensing Synchron Control hydraulic system with flow-on-demand control and fuel-saving zero-flow control. Fine-mode control. Max. pump capacity .580 l/min (153 US gal./min)
Operating pressure 320 bar (4640 psi)
. 360 bar (5220 psi)
Hydraulic oil tank 380 l (100 US gal.)
Pump capacity/speed with 100% to 50% adjustment range to optimize fine control performance. Hydraulic oil radiator in separate cooling circuit. Hydraulic fan activated on demand.

 **Cab** New cab design for optimum all-round visibility. Orthopedic, air-cushioned comfort seat with lumbar support, armrests and neck support, multi-adjustable to suit the driver. Infinitely variable height-adjustable cab with max. eye level of 5.6 m (18' 5"). Ergonomically shaped control levers, clearly arranged monitoring instruments, adjustable steering column. 3-stage hot water fan heating. Combined ventilation and heating system. Adjustable air vents provide optimum ventilation of cab. Air conditioning and special ventilation systems available as an option.

 **Swing system** Drive through swash plate motor and planetary gear, integrated drive pinions on internally toothed ring gear. Power swing brake system, pedal lockable by foot. Soft braking through motor-integrated brake valves. The gearing is greased by the central lubricating system provided as standard.
Uppercarriage swing speed 0–8 r.p.m.

 **Work equipment / Operating data**
Operating weight with 15 m (49' 3") loading equipment, 0.6 m³ (0.8 yd³) cactus grab and generator system approx. 31.5 t (69,450 lbs)
Reach with box-type boom and dipperstick
. 15 m (49' 3")/13.5 m (44' 3")
Reach to tip of tine, open grabs
. 16.2 m (53' 2")/ 14.7 m (48' 2")
4 work cylinders Ø 140/90mm (5.5"/3.5")
Generator system, optional, 2 choices 13kW/20 kW
Clearance height 3.8 m (12' 6")
Loading height 3.55 m (11' 6")
Standard version: Turning radius at outside edge of tires 8.2 m (26' 11")
Four-wheel steering (option): Turning radius at outside edge of tires 5.0 m (16' 5")

 **Fluid capacities** Fuel tank 350 l (92.5 US gal.)

 **Grabs** Cactus grab with cast central case and enclosed swing drive. Grab jaws with wear-resistant grab liners and tips.

Safety equipment when machine is used for crane operations acc. to EN 474-5. Protection of cab through work equipment operating range limit, proximity switch for protection of uppercarriage access.

Official homologation The machine has CE-approval (confirmed by German Civil Engineering Trade Association) and fulfills EEC-construction standards and requirements according to the Dynamic Measurement Method (86/662 EEC, Appendix 2).
Sound pressure level: L_{PA} = 74 dB(A)
Sound power level: L_{WA} = 104 dB(A)

Transport weights and dimensions

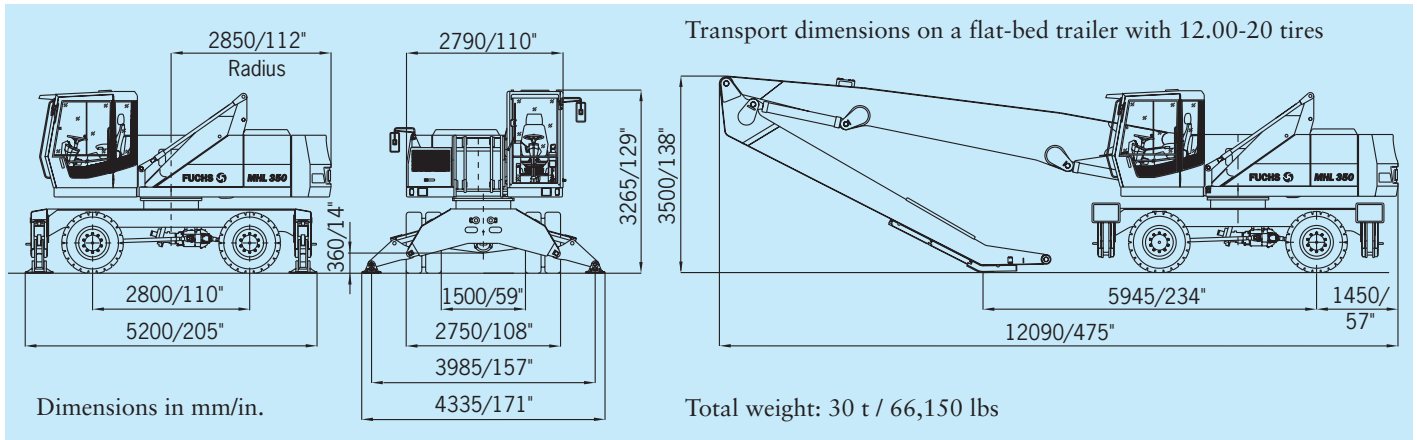

Working range diagram 15 m (49.2 ft.) reach

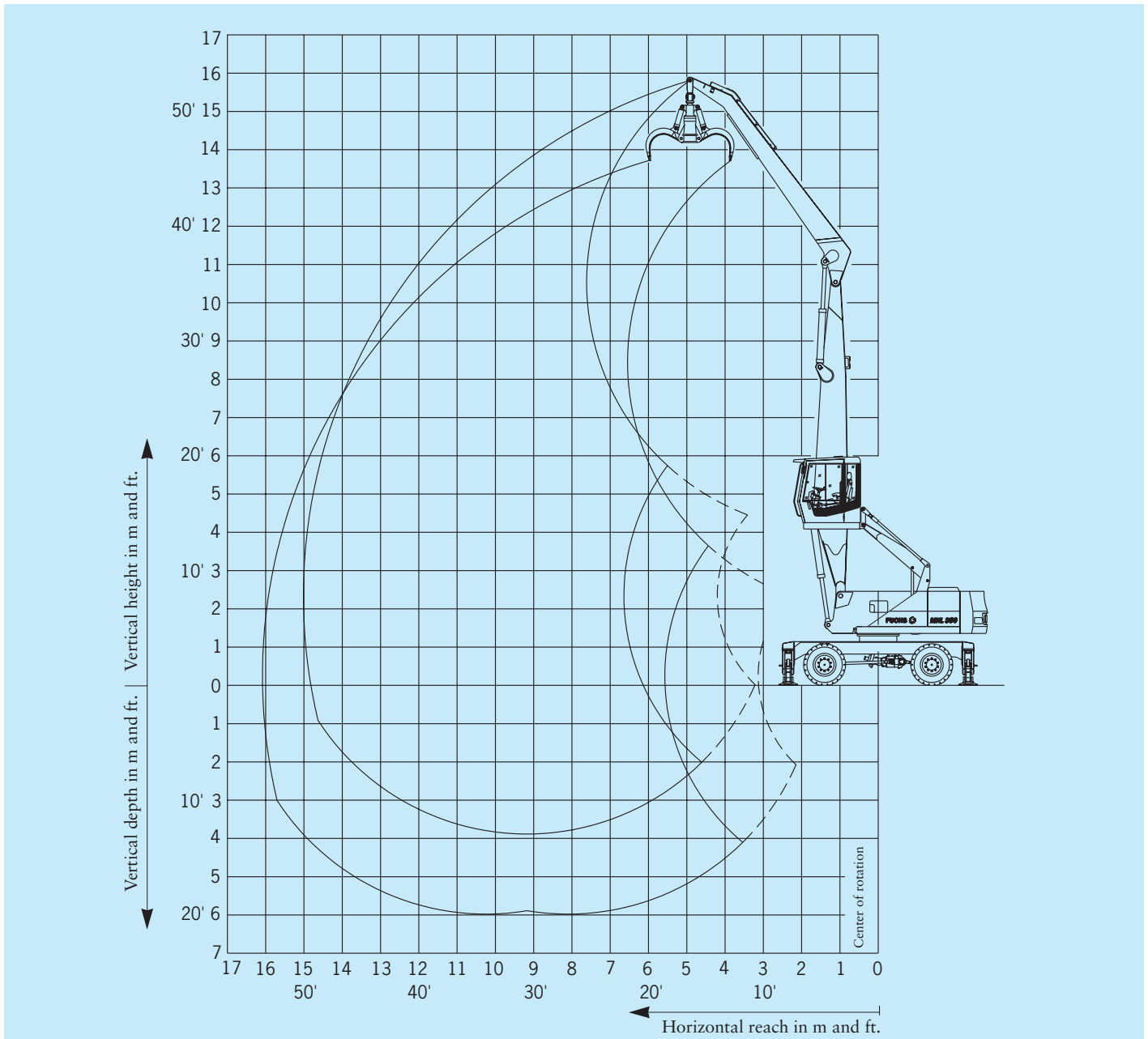

Lifting capacities

Work equipment: box-type boom 8.2 m (26.9 ft.), dipperstick 6.5 m (21.3 ft.), reach 15 m (49.2 ft.)

Height in m	Undercarriage outriggers	Reach in m							
		4.5	6	7.5	9	10.5	12	13.5	15
12	not supported			(5.9)	(4.6)	(3.5)			
	4-point-supported			5.9** (5.9**)	5.5* (5.5**)	5.1 (5.3**)			
10.5	not supported				(4.6)	(3.6)	(2.8)		
	4-point-supported				5.4** (5.4**)	5.1** (5.1**)	4.1 (4.8**)		
9	not supported			(5.8)	4.6	(3.6)	(2.8)	(2.3)	
	4-point-supported			5.8 (5.9**)	5.4** (5.4**)	5.1** (5.1**)	4.1 (4.8**)	3.4 (4.4)	
7.5	not supported			(6.0)	(4.5)	(3.5)	(2.8)	(2.3)	
	4-point-supported			6.2** (6.2**)	5.6** (5.6**)	5.1 (5.2**)	4.1 (4.8**)	3.4 (4.4)	
6	not supported		(7.8**)	(5.8)	(4.4)	(3.4)	(2.7)	(2.2)	
	4-point-supported		7.8** (7.8**)	6.8** (6.7**)	6.0** (6.0**)	5.0 (5.4**)	4.1 (5.0)	3.4 (4.3)	
4.5	not supported	(11.9)	(7.7)	(5.5)	(4.2)	(3.3)	(2.7)	(2.2)	
	4-point-supported	12.1** (12.1**)	9.2** (9.2**)	7.6** (7.6**)	6.1 (6.5**)	4.9 (5.7)	4.0 (5.1)	3.3 (4.3)	
3	not supported	(10.6)	(7.0)	(5.2)	(4.0)	(3.2)	(2.6)	(2.1)	(1.8)
	4-point-supported	15.5** (15.5**)	10.7 (10.8**)	7.7 (8.4**)	5.9 (6.9)	4.7 (6.0)	3.9 (5.0)	3.2 (4.2)	2.8 (3.7)
1.5	not supported		(6.5)	(4.8)	(3.8)	(3.0)	(2.5)	(2.1)	1.8
	4-point-supported		10.2 (12.0**)	7.4 (9.1**)	5.7 (7.4)	4.6 (6.0)	3.8 (5.0)	3.2 (4.2)	2.8 (3.7)
0	not supported		(6.1)	(4.6)	(3.6)	(2.9)	(2.4)	(2.0)	
	4-point-supported		9.8 (11.9*)	7.1 (9.5)	5.5 (7.3)	4.5 (5.9)	3.7 (4.9)	3.1 (4.1)	
- 1.5	not supported		(5.9)	(4.4)	(3.5)	(2.8)	(2.4)	(2.0)	
	4-point-supported		9.5 (10.0*)	6.9 (9.4)	5.4 (7.2)	4.4 (5.8)	3.7 (4.8)	3.1 (4.1)	
- 3	not supported		(5.9)	(4.3)	(3.4)	(2.8)	(2.3)		
	4-point-supported		9.5 (10.0*)	6.8 (9.2)	5.3 (7.1)	4.3 (5.7)	3.6 (4.8)		

Height in ft.	Undercarriage outriggers	Reach in ft.							
		15	20	25	30	35	40	45	50
40	not supported			(13,005)	(10,140)	(7,715)			
	4-point-supported			13,005** (13,005**)	12,125* (12,125**)	11,245 (11,685**)			
35	not supported				(10,140)	(7,935)	(6,170)		
	4-point-supported				11,905** (11,905**)	11,245** (11,245**)	9,040 (10,580**)		
30	not supported			(12,785)	10,140	(7,935)	(6,170)	(5,070)	
	4-point-supported			12,785 (13,005**)	11,905** (11,905**)	11,245** (11,245**)	9,040 (10,580**)	7,495 (9,700)	
25	not supported			(13,225)	(9,920)	(7,715)	(6,170)	(5,070)	
	4-point-supported			13,670** (13,670**)	12,345** (12,345**)	11,245 (11,245**)	9,040 (10,580**)	7,495 (9,700)	
20	not supported		(17,195**)	(12,785)	(9,700)	(7,495)	(5,950)	(4,850)	
	4-point-supported		17,195** (17,195**)	14,990** (14,770**)	13,225** (13,225**)	11,025 (11,905**)	9,040 (11,023)	7,495 (9,480)	
15	not supported	(26,235)	(16,975)	(12,125)	(9,260)	(7,275)	(5,950)	(4,850)	
	4-point-supported	26,675** (26,675**)	20,280** (20,280**)	16,755** (16,775**)	13,450 (14,330**)	10,800 (12,565)	8,820 (11,245)	7,275 (9,480)	
10	not supported	(23,370)	(15,430)	(11,465)	(8,820)	(7,005)	(5,730)	(4,630)	(3,970)
	4-point-supported	34,170** (34,170**)	23,590 (23,810**)	16,975 (18,520**)	13,005 (15,210)	10,360 (13,225)	8,595 (11,025)	7,055 (9,260)	6,170 (8,155)
5	not supported		(14,330)	(10,580)	(8,375)	(6,615)	(5,510)	(4,630)	3,970
	4-point-supported		22,485 (26,455**)	16,135 (20,060**)	12,565 (16,315)	10,140 (13,225)	8,375 (11,025)	7,055 (9,260)	6,170 (8,155)
0	not supported		(13,450)	(10,140)	(7,935)	(6,395)	(5,290)	(4,410)	
	4-point-supported		21,605 (26,235*)	15,650 (20,945)	12,125 (16,095)	9,920 (13,005)	8,155 (10,800)	6,835 (9,040)	
- 5	not supported		(13,005)	(9,700)	(7,715)	(6,170)	(5,290)	(4,410)	
	4-point-supported		20,945 (22,045*)	15,210 (20,725)	11,905 (15,875)	9,700 (12,785)	8,155 (10,580)	6,835 (9,040)	
- 10	not supported		(13,005)	(9,480)	(7,495)	(6,170)	(5,070)		
	4-point-supported		20,945 (22,045*)	14,990 (20,280)	11,685 (15,650)	9,480 (12,565)	7,935 (10,580)		

The carrying capacity values are stated in tons (t) or lbs. The pump pressure for this table is 360 bar/5220 psi. The values amount to 75% of the static tipping load or 87% of the hydraulic lifting force, in accordance with ISO 10567.

When the machine is standing on solid, even ground, these values apply to slewing operations through 360°. The values in brackets apply in the lengthwise direction of the undercarriage. The "unsupported" values apply only when the load is hoisted above the front or rear axle.

The weight of the attached load hoisting implement (grab, magnet, load

hook, etc.) must be deducted from the carrying capacity values. When the FUCHS quick-mount hitch is attached to the boom, carrying capacity values are reduced by 300 kg.

* limited by dipperstick cylinders

** limited by lift cylinders

In accordance with EC guidelines, hose-rupture safety valves on the lift cylinders and an overload warning device are required for crane operations.

Built for the purpose



1



2



3



4

- 1 The MHL 350 is the ideal machine for loading and unloading of scrap, sand, gravel or timber from ships and barges.
- 2 Loading a rail car using a cactus grab.
- 3 Ergonomically arranged instruments & operator controls.
- 4 Designed from the ground up to be service-friendly. All assemblies are easily accessible thanks to the pull-out service ladder.

Work equipment

Box-type boom with lift and dipperstick cylinders

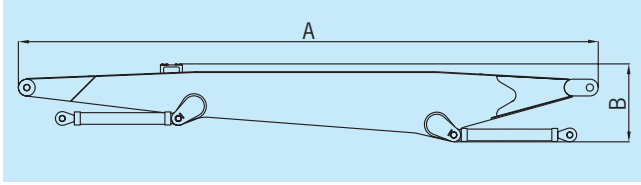

Reach m (in.) 13.5/15 (44'3"/49'3")
 Boom m (in.) 7.4/8.2 (24'3"/26'9")
 Width mm (in.) 876/876 (35"/35")
 Dimension A mm (in.) 7645/8445 (301"/332")
 Dimension B mm (in.) 1135/1135 (45"/45")
 Weight with lift and dipperstick cylinders kg (lbs) . . 2965/3065 (6540/6755)
 Weight without lift and dipperstick cylinders kg (lbs) . . 2140/2240 (4720/ 4940)

Dipperstick

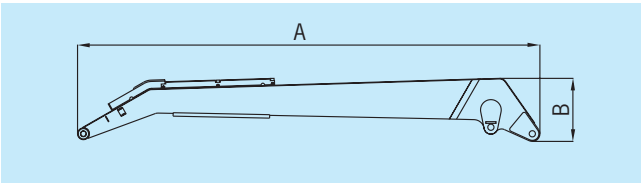

Reach m (in.) 13.5/15 (44'3"/49'3")
 Stick m (in.) 5.8/6.5 (19'/21'3")
 Width mm (in.) 876/876 (35"/35")
 Dimension A mm (in.) 5995/6695 (236/265")
 Dimension B mm (in.) 915/915 (36/36")
 Weight kg (lbs) 1150/1250 (2535/2760)

Magnet hydraulically slewable

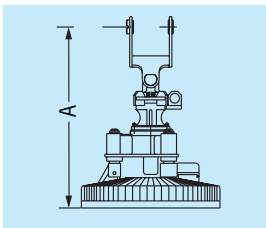

Diameter Ø . . 1150 mm (45")
 1250 mm (49")
 Dimension A 1488 mm (58.5")
 1513 mm (59.5")
 Weight . . 1570 kg (3460 lbs)
 1865 kg (4110 lbs)
 Magnets with quick-mount suspension: total weight increased by 40 kg (88.2 lbs).

(For further magnets see separate data sheet)

Load hook

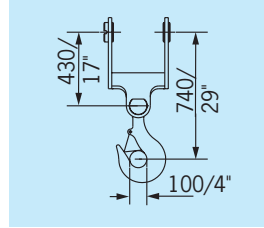

Rigid or slewable suspension

Permissible lifting capacity 10 t (22,045 lbs)
 Weight 90 kg (200 lbs)

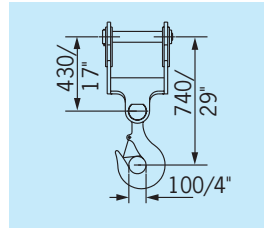

Rigid or slewable quick-mount suspension

Permissible lifting capacity 10 t (22,045 lbs)
 Weight 130 kg (290 lbs)

Cactus grab

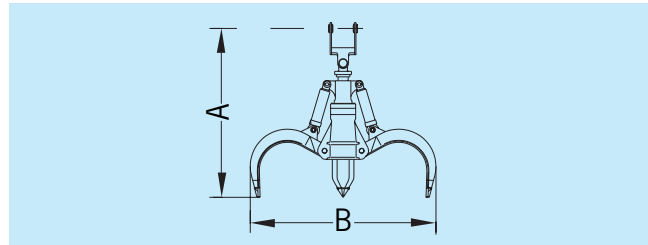

Capacity in m ³	A mm	B mm	Weight in kg		
			open	semi-open	closed
0.4	2020	2030	1250	1340	1370
0.6	2050	2360	1360	1490	1540
0.85	2160	2700	1550	1790	1860

Capacity in yd ³	A in.	B in.	Weight in lbs		
			open	semi-open	closed
0.5	79"	80"	2755	2960	3020
0.8	81"	93"	3000	3290	3400
1.1	85"	106"	3480	3950	4100

Grabs with quick-mount suspension: total weight increased by 40 kg (88.2 lbs).



FUCHS

MHL 350 valid from machine no. 368. 02.2000 GB/US (3) Printed in Germany
 Subject to change without notice. This brochure contains data which may vary from the standard extent of supply.